



**Flexible**



**Steel**



**Replacement**



**New Curb**

## **Tie Stalls**



**CK Manufacturing, LLC**

**THE DAIRY BARN SPECIALISTS**

[www.ckmanufacturing.com](http://www.ckmanufacturing.com)

## ***They Moo-ve Just the Right Amount*** ***The safest, most comfortable tie stall available***

Our Flexible Tie Stalls with rubber are rigid enough to maintain structural support, yet flexible enough to reduce injuries.



### ***Tie Stalls***

Our flexible tie stall blends the characteristics of our traditional tie stall with the benefits of plastics.

#### **Benefits**

- Provides a sturdy, flexible framework to allow freedom of movement while minimizing injuries to cows and people
- Increases cow comfort
- Does not oxidize
- Available as ***Replacement Stalls and New Curb Stalls.***



## Flexible Tie Stalls

Item	Description
7100FSR	Flexible Regular Loop (new curb) with Easyfix tubing & loop

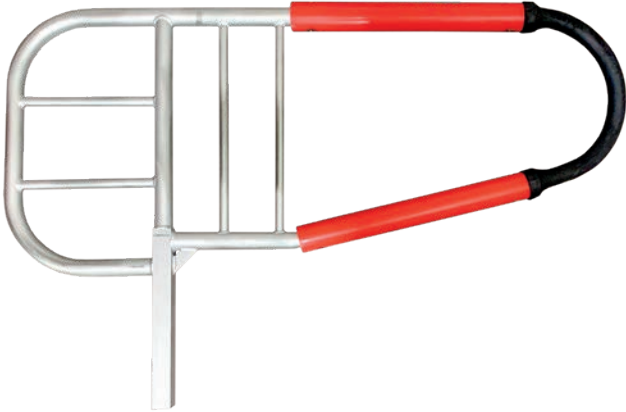
A metal tie stall frame with a red Easyfix tubing loop and a black Easyfix tubing loop.

Item	Description
H7008FSW	Flexible Waterbowl Loop (new curb) with Easyfix tubing & loop

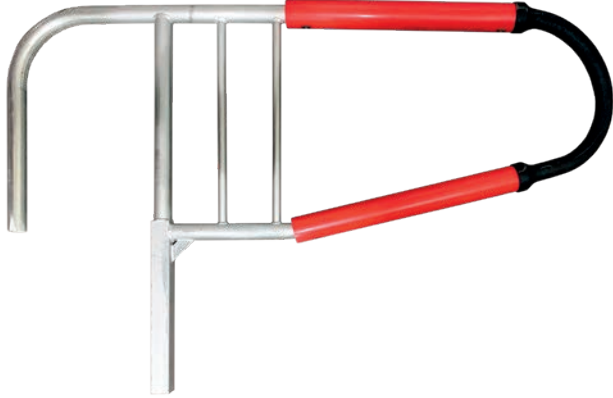
A metal tie stall frame with a red Easyfix tubing loop and a black Easyfix tubing loop, designed for waterbowl use.

Item	Description
H71008FSE	Flexible End Loop with corner saver (new curb) with Easyfix tubing & loop (R.H. shown)

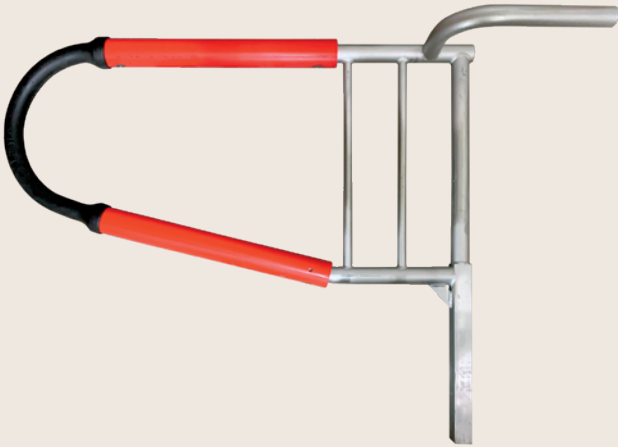
A metal tie stall frame with a red Easyfix tubing loop and a black Easyfix tubing loop, shown from the right side.

Item	Description
H71008FSE	Flexible End Loop with corner saver (new curb) with Easyfix tubing & loop (L.H. shown)

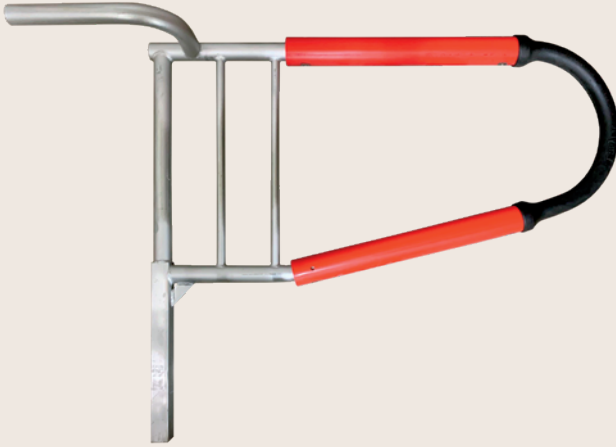
A metal tie stall frame with a red Easyfix tubing loop and a black Easyfix tubing loop, shown from the left side.

## Flexible or Steel

**Making renovations easy. Replace your worn out stalls while saving your existing curb!**



- **Save time:** Our stalls are finished in as little as one day.
- **Save money:** Because our replacement stalls will fit your existing curb, there are no masons or concrete to pay for.
- **Long-term increased production:** The position of our water bowls means your cows drink more water: More Water = More Milk.
- **No loss in production:** Your cows will be back in their stalls the same day. Our crews start after your morning milking & finish before your evening milking.
- **Optional:** Stainless steel tie rail

### 40 new stalls in less than 8 hours!

Our crews will begin by cutting off the old stalls and stripping the old curb clean. Next, the new stall components are slid into the existing pipe in the curb. The new stall is then welded to our heavy-duty anchor plate and anchored with two stainless steel anchor bolts.



### Tight Corners?

Corner savers are standard on all end loops.

- Manufactured with 1.90 ten gauge tubing.
- Two vertical pipes to eliminate grain stealing.
- 2" of solid square stock is machined to fit into upright pipe for extra strength.
- End loops feature our unique corner saver, which allows 4" more clearance for feed carts, etc.
- Special sizes available for Jerseys.

*"The flex stall is so much easier on cows and their handlers. Cows are more relaxed when you let them out. They don't fight the stalls like they do a solid steel loop. Cows move in and out more easily."*

Daniel Smucker  
Paradise, PA

**Yes! We really have solid square stock anchor systems.**



CK believes the base is the foundation to a great stall system. So you will not find hollow tubing anchoring our stalls. Instead, we use solid square stock. Heavy-duty construction continues throughout our stall with features such as a second divider pipe so your cow stays where it belongs.

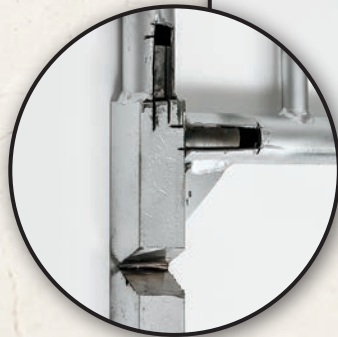
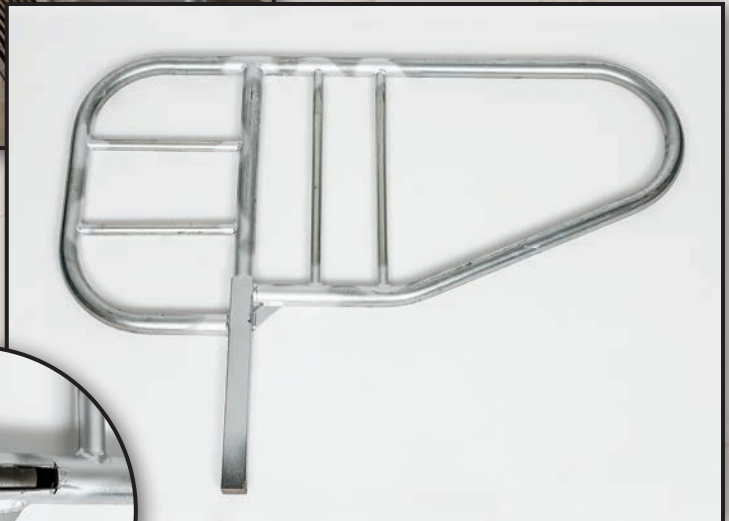

## **Concrete Services**

**We offer expert concrete services for all of your new barn or renovation needs**



# Galvanized Tie Stalls



Description
<ul style="list-style-type: none"> <li>• Manufactured with 1.90 O.D. ten gauge tubing</li> <li>• 2" square solid steel base</li> <li>• Two vertical pipes to eliminate grain stealing</li> </ul>

Options
<ul style="list-style-type: none"> <li>• 43" regular or 34" Jersey loop length</li> <li>• Galvanized or powder-coated</li> <li>• Custom machining to adjust for curb height</li> </ul>

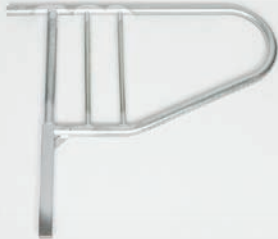

Recommended stall height is 41" above cowbed before mattress.

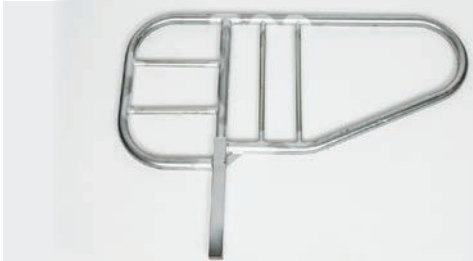

## Tie Stall Loops (New Curb)

Item	Description
H71008E	End Loop w/corner saver (new curb,) L.H. shown
H71008RPC	End Loop w/corner saver (new curb) Powder-coated
	
H71008NFD	Loop w/out Front Divider (new curb)
H71008NFDPC	New Curb Loop w/out Front Divider (Powder-coated)
	

Item	Description
H71008R	Regular Loop (new curb)
H71008RPC	Regular Loop (new curb) Powder-coated
	
H71008W	Water Bowl Loop (new curb)
H71008WPC	Water Bowl Loop (new curb) Powder-coated
	

## Jersey Tie Stall Loops (New Curb)

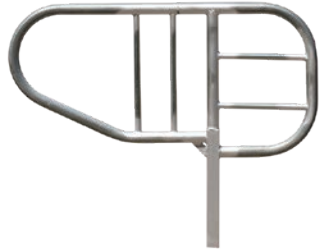
Item	Description
JNC221E	Jersey End Loop w/corner saver (new curb), L.H. shown
JNC221EPC	Jersey End Loop w/corner saver (new curb) (Powder-coated),
	
JNC221NFD	Jersey Loop w/ out Front Divider (new curb)
JNC221NFDPC	Jersey Loop w/ out Front Divider (new curb) (Powder-coated)
	

Item	Description
JNC221R	Jersey Regular Loop (new curb)
JNC221RPC	Jersey Regular Loop (new curb) (Powder-coated)
	
JNC221W	Jersey Water Bowl Loop (new curb)
JNC221WPC	Jersey Water Bowl Loop (new curb) (Powder-coated)
	

## Tie Stall Loops (Replacement)

Item	Description
------	-------------

82002ME End Loop w/corner saver (Replacement Stall) 14" square, R. H. shown



82002MNFD Loop w/out Front Divider (Replacement 14" square)



82002MR Regular Loop (Replacement Stall) 14" square



82002MW Water Bowl Loop (Replacement Stall) 14" square



Item	Description
------	-------------

82021ME End Loop w/corner saver (Replacement Stall) 12" square, L. H. shown



82021MNFD Loop w/out Front Divider (Replacement 12" square)

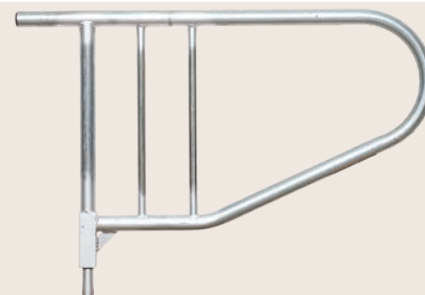

82021MR Regular Loop (Replacement Stall) 12" square



82021MW Water Bowl Loop (Replacement Stall) 12" square



## Tie Stall Loops (Curb Build-up)

Item	Description
------	-------------

CB2958E End loop - w/corner saver (Curb Built Up Stall)

CB2958NFD Loop w/out Front Divider (Curb Built up)



Item	Description
------	-------------

CB2958R Regular Loop (Curb Built Up Stall)

CB2958W Water Bowl Loop (Curb Built Up Stall)

# Tie Stall Accessories

## Cross Clamps

Item	Description		Item	Description	
CC112	Set cross clamps HD 1½" x 1½" 10 ga.		HCC15GALV	Heavy cross clamp 1½" (1 piece) (Galv.)	
CC112114	Set cross clamp HD 1½" x 1¼"		HCC20	Heavy cross clamp 2" (1 piece) (Powder-coated)	
CC114	Set Cross Clamps HD 1¼" x 1¼"		HCC2020	Heavy Cross clamp 2" x 2" (Powder-coated)	
HCB1415HGALV	Clamp bushing 1½" x 1¼" pipe (half) (Powder-coated)		HCC2020GALV	Heavy Cross Clamp 2"x2" (Galv.)	
HCB1415HK	Clamp bushing 1½" x 1¼" pipe (halves) (Powder-coated)		HCC20GALV	Heavy cross clamp 2" (1 piece) (Galv.)	
HCB1415HKGALV	Clamp bushing 1½" x 1¼" pipe (halves) (Galv.)		LCC1414	Light cross clamp 1¼ x 1¼ (Powder-coated) 12 ga.	
HCC15	Heavy cross clamp 1½" (1 piece) (Powder-coated)		LCC1414GALV	Light cross clamp 1¼ x 1¼ (Galv.)	
HCC1515	Heavy Cross clamp 1½ x 1½" pipe (Powder-coated) 8 ga.		LCC1415	Light cross clamp 1¼ x 1½ (Powder-coated)	
HCC1515GALV	Heavy Cross Clamp 1½" x 1½" (Galv.)		LCC1415GALV	Light cross clamp 1¼ x 1½ (Galv.)	
HCC1520	Heavy cross clamp 1½" x 2" pipe (Powder-coated)		LCC1515	Light cross clamp 1½ x 1½ (Powder-coated)	
HCC1520GALV	Heavy Cross Clamp 1½" x 2" Pipe (Galv.)		LCC1515GALV	Light cross clamp 1½ x 1½ (Galv.)	





## Column Clamps



Item	Description		Item	Description	
LCL2015	Light column clamp 2" x 1½" (Powder-coated)		LCL3515GALV	Light column clamp 3½ x 1½ (Galv.)	
LCL2015GALV	Light column clamp 2" x 1½" (Galv.)		LCL4015	Light column clamp 4 x 1½ (Powder-coated)	
LCL2515	Light column clamp 2½ x 1½ (Powder-coated)		LCL4015GALV	Light column clamp 4 x 1½ (Galv.)	
LCL2515GALV	Light column clamp 2½ x 1½ (Galv.)		LCL5015	Light Column Clamp 5" x 1½" (Powder-coated)	
LCL3015	Light column clamp 3 x 1½ (Powder-coated)		LCL5015GALV	Light Column Clamp 5" x 1½" (Galv.)	
LCL3015GALV	Light column clamp 3 x 1½ (Galv.)		LCL6015	Light Column Clamp 6 x 1½ (Powder-coated)	
LCL3515	Light column clamp 3½ x 1½ (Powder-coated)		LCL6015GALV	Light Column Clamp 6 x 1½ (Galv.)	

# Tie Stall Accessories



## 4 Way Clamps



Item	Description	
LFW1414	Four way clamp 1/4" x 1/4" (Powder-coated)	
LFW1414GALV	Four way clamp 1/4" x 1/4" (Galv.)	

## Wall Flanges

Item	Description	
LWF1400	Wall flange 1/4" x 1/2" pipe (Powder-coated)	
LWF1400GALV	Wall flange 1/4" x 1/2" pipe (Galv.)	

## Tee Clamps

Item	Description	
LTC1400	1/4" x 1/4" Tee Clamp (1 pc.)	
LTC1414K	Tee clamp 1/4" x 1/4" pipe (For 1 1/2" x 1 1/2" pipe use 3/8" x 1 1/2" bolts) (Powder-coated)	
LTC1414KGALV	Tee clamp 1/4" x 1/4" pipe (Galv.) (For 1 1/2" x 1 1/2" pipe use 3/8" x 1 1/2" bolts)	

Item	Description	
LTC1514K	Tee clamp 1 1/2" x 1 1/4" pipe (Powder-coated)	
LTC1514KGALV	Tee clamp 1 1/2" x 1 1/4" pipe (Galv.)	

## Riser Pipes



Item	Description
RP24	1 5/8" Riser Pipe 24" (Powder-coated)
RP24GALV	1 5/8" Riser Pipe 24" (Galv.)
RP30	1 5/8" Riser Pipe 30" (Powder-coated)
RP30GALV	1 5/8" Riser Pipe 30" (Galv.)
RP36	1 5/8" Riser Pipe 36" (Powder-coated)
RP36GALV	1 5/8" Riser Pipe 36" (Galv.)

Item	Description
RP42	1 5/8" Riser Pipe 42" (Powder-coated)
RP42GALV	1 5/8" Riser Pipe 42" (Galv.)
RP48	1 5/8" Riser Pipe 48" (Powder-coated)
RP48GALV	1 5/8" Riser Pipe 48" (Galv.)
RP54	1 5/8" Riser Pipe 54" (Powder-coated)
RP54GALV	1 5/8" Riser Pipe 54" (Galv.)

## Tie Stall Accessories























Item	Description		Item	Description	
1008EPDM	1/2" flex hose (per foot)		7715830	Metallic top coat paint	
1012EPDM	3/4" flex hose (per foot)		BBV1	1" brass ball valve	
1016EPDM	1" flex hose (per foot)		BBV112	1/2" brass ball valve	
12175UV	11" heavy duty cable tie		BPP112	1 1/2" black plastic 100 psi pipe (Per Ft.)	
1x1PT	1" plastic Tee		CC45B	Cow collar (Blue) 45"	
2HP3836	2 Hole plate 3/8" x 3" x 6"		GRR158212	1 5/8" x 2.5" CR shaft	
619-3999	Teflon tape		CS199010	Corner saver	
62606	Hose clamp stainless steel 5/16"-7/8" narrow		CT3509	Cow trainer	
6392690	1" Nylon elbow		ELB199010	End loop brace	
6812	6812 stainless steel hose clamp (for 1/2" & 3/4" hose)		FDW38*112	3/8" ID x 1 1/2" OD Fender washer	
6820	6820 stainless steel hose clamp (for 1" hose)		FF112B	1 1/2" floor flange	
6824	6824 stainless steel hose clamp (for 1.25" hose)		G14225	3" Gusset	
6836	6836 stainless steel clamp (for 2" hose)		GA4425	4" x 4" x 1/4" Galv. angle 14" pcs.	

# Tie Stall Accessories

## Tie Stall Accessories - Continued



Item	Description		Item	Description	
GTP	Gate Tube Plug		NS1	1" Nylon Splicer	
HH12	1/2" Hyd. Hose (per ft.)		P3826CB	Flat plate to weld to curb built up stall	
HS34	3/4" Hose spigot		P50	Planitop (50 LB. bag)	
INSR	Instarok Cement-50 LB. Pail		PC1122	1 1/2" x 2" Parallel Clamp (per set)	
LTS1400	Tie chain clamp 1 1/4" pipe		PC22	2" parallel clamp (per set)	
LTS1500	Tie chain clamp 1 1/2" pipe		PLB61310	Pipeline L Bracket	
ML429584	Megaloc		PPR7/8*10-14	Plastic Pipe Plug	
MS1587	1 5/8" x 7" C.R. machined shaft		PS1	1" 2 hole pipe strap	
NC40	Cow neck chain 40"		PS112	1 1/2" 2 hole pipe strap	
NCR40	Cow neck chain ring		PS114	1 1/4" 2 hole pipe strap	
NE34	3/4" Nylon Elbow		PS2	2" 2 hole pipe strap	
			PS34	3/4" 2 hole pipe strap	
			PUB61305	Blue Pipeline U Bracket	

## Tie Stall Accessories - Continued

Item	Description		Item	Description	
QL14	Tie chain quick links		SUB2SS	U Bolt (For 2" Saddle Kit) Stainless Steel	
RT12	Plastic pipe plug (for 1¼" pipe)		TC14134	¼" x 1¼" Hex Head Tapcon (per pc.)	
RT14	Plastic pipe plug (for 1½" pipe)		TC14234	¼" x 2¾" Hex Head Tapcon	
SD38114	Swing divider		TC22	Complete Tie Chain w/out Clamp (28" Long) Jersey	
SD38114K	Swing Divider Kit		TC25	Complete tie chain w/o clamp (31" Long)	
SDCCH15GALV	1½" Cross Clamp hinge		TC33	Complete tie chain w/out clamp (39" Long)	
SK112SS	1½" Saddle kit ** Stainless Steel **		TCS125SS	1¼" Stainless Steel Tie Chain Snap	
SK2SS	Stainless steel 2" saddle kit		TE238108	8" Tie Rail Extension Bracket (Powder-coated)	
SN1122SS	½" Nipple (For 1½" & 2" Saddle Kit) Stainless Steel		TE238108GALV	8" Tie Rail Extension Bracket (Galv.)	
SP1122SS	Plate (For 1½" & 2" Saddle Kit) Stainless Steel		TSD0	1-½" saddle kit	
SSWA12412	½" x 4¼" stainless steel anchor bolt		VC2114	2 x 1¼" vacuum line clamps	
SUB112SS	U Bolt (For 1½" Saddle Kit) Stainless Steel		WA12412	½" x 4½" Wedge Anchor	

# Tie Stall Accessories

## Tie Stall Accessories - Continued

Item	Description	
WB1118	Wall brackets	
WBLRP10	10" Water Bowl Loop Repair Pipe	
ZC14	1/4" Zinc S-3 Proof Coil Chain (Per ft.)	



Item	Description	
ZC316	3/16" proof coil chain (per foot)	
ZRC	ZRC paint (per can)	

## Brass and Stainless Steel Hose Barbs

Item	Description	
A100BR	1 x 1 brass barb	
A12100BR	1/2" x 1" Brass barb	
A1212BR	1/2" x 1/2" Brass Adapter	
A1212SS	1/2" x 1/2" Barb Stainless Steel	
A1234BR	1/2" x 3/4" Brass Barb	















Item	Description	
A1234SS	1/2" x 3/4" Barb Stainless Steel	
A34100BR	3/4" x 1" brass barb	
A3412BR	3/4" x 1/2" brass barb	
A3434BR	3/4" x 3/4" brass barb	

## Galv. Tie Rail Pipe & Pipe Fittings

Item	Description	
GP112SCH40	1 1/2" sch 40 Galv. pipe (Tie Rail) (per foot)	
610-0424	1" x 3/4" bushing (Galv.)	
610-0457	1 1/4" x 1" bushing (Galv.)	
610-0473	1 1/2" x 3/4" bushing (Galv.)	
610-0481	1 1/2" x 1" bushing (Galv.)	
610-0499	1 1/2" x 1 1/4" bushing (Galv.)	

Item	Description	
610-0747	1 1/2" Elbow (Galv.)	
610-0952	1 1/2" x 1" reducing Ell (Galv.)	
610-1331	1 1/2" St. Ell (Galv.)	
610-1513	1 1/2" Tee (Galv.)	
610-2339	1 1/2" cap (Galv.)	
QC112	1 1/2" Coupler (Galv.)	

## Galv. Tie Rail Pipe & Pipe Fittings - Continued

Item	Description		Item	Description	
610-2602	1½" x ¾" bell reducer (Galv.)		612-6346	¾" x 4" nipple (Galv.)	
610-2958	1½" x 1" bell reducer (Galv.)		612-6460	1" x 3" nipple (Galv.)	
610-2966	1½" x 1¼" bell reducer (Galv.)		612-6486	1" x 4" nipple (Galv.)	
610-3170	1½" plug (Galv.)		612-6577	1¼" x 3" nipple (Galv.)	
610-3469	1½" union (Galv.)		612-6692	1½" x 3" Nipple (Galv.)	
612-6304	¾" x 2" nipple (Galv.)		612-6742	1½" x 6" Nipple (Galv.)	
			642-1713	1½" Coupling (Galv.)	
			689-8019	1½" Four Way (Galv.)	

## Stainless Steel Tie Rail Pipe & Pipe Fittings

Item	Description		Item	Description	
SSP112SCH40	1½" sch. 40 T&C Stainless Steel Pipe (Tie Rail) (per foot)		SSB1121	1½" - 1" Stainless Steel Bushing	
TF12SS	Pipe Tape (For Stainless Steel Pipe)		SSB11234	1½" - ¾" Stainless Steel Bushing	
BV112SS	1½" Stainless Steel Ball Valve		SSB134	1" - ¾" Stainless Steel Bushing	
BV1SS	1" Stainless Steel Ball Valve		SSC112	1½" (304) Stainless Steel Coupler	
BV34SS	¾" Stainless Steel Ball Valve		SSCP112	1½" Stainless Steel Cap	
MA112IS	1½" x 1½" Stainless Steel Adapter		SSE112	1½" Stainless Steel Elbow	
MA114IS	1¼" x 1¼" Stainless Steel Adapter		SSN1123	1½" x 3" Stainless Steel Nipple	

# Tie Stall Accessories

## Stainless Steel Tie Rail Pipe & Pipe Fittings - Continued

Item	Description		Item	Description	
SSN13	1" x 3" Stainless Steel Nipple		SSSE112	1½" Stainless Steel Street Elbow	
SSN343	¾" x 3" Stainless Steel Nipple		SST112	1½" Stainless Steel Tee	
SSP112	1½" Stainless Steel Plug				







## PVC Pipe & Pipe Fittings

Item	Description		Item	Description	
002-6112	PVC cleaner 16 oz.		PB2112	2 x 1½ PVC Bushing / spig x Fipt	
089-6472	PVC glue 16 oz. (Harvey's)		PB2114	2 x 1¼ PVC Bushing / spig x Fipt	
2PC	2" PVC Cap (soc.)		PB212	2 x ½ PVC Bushing / spig x Fipt	
PB1121	1½ x 1 PVC Bushing / spig x Fipt		PB234	2 x ¾ PVC Bushing / spig x Fipt	
PB112114	1½ x 1¼ PVC Bushing / spig x Fipt		PBV112	1½" PVC Ball Valve	
PB11212	1½ x ½ PVC Bushing / spig x Fipt		PBV2	2" PVC Ball Valve Soc.	
PB11234	1½ x ¾ PVC Bushing / spig x Fipt		PC112	1½ PVC Coupling (Soc.)	
PB21	2 x 1 PVC Bushing / spig x Fipt		PC15	1½" PVC cap	
			PC2	2" PVC Coupling (Soc.)	



## PVC Pipe & Pipe Fittings - Continued

Item	Description	
PC212	2½" Sch. 40 PVC Cap	
PC3	3" PVC cap	
PC4	4" Sch. 40 PVC Cap	
PC5	5" Sch. 40 PVC Cap	
PE112	1½ 90 deg. PVC SOC. Elbow	
PE2	2" 90 deg. PVC SOC. Elbow	
PFA112	1½ PVC Female Adapter / soc x Fipt	
PFA2	2" PVC Female Adapter / soc x Fipt	

Item	Description	
PMA112	1½ PVC Male Adapter / Mipt x soc	
PMA2	2" PVC Male Adapter / Mipt x soc	
PP112	1½" PVC pipe sch. 40 (per foot)	
PP2	2" PVC pipe sch. 40 (per foot)	
PP3	3" PVC pipe sch. 40 (per foot)	
PRT234	2 x ¾ PVC Reducing Tee/ soc x Fipt	
PT112	1½" PVC Tee socket	
PT2	2" PVC Tee socket	

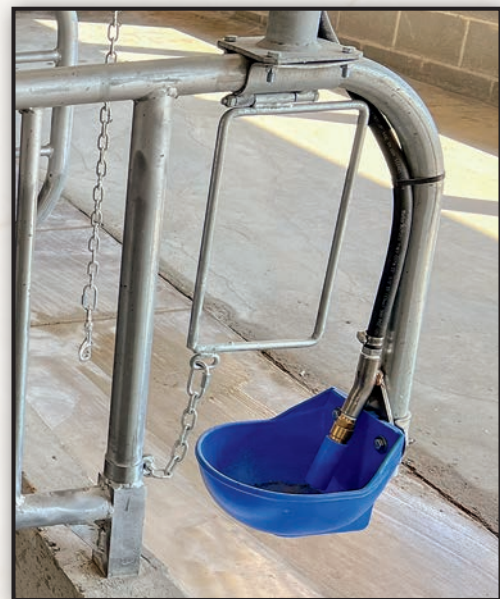

# Waterers, Mats & Feeders

## Water Bowl Parts

Item	Description	
92RWU	Washer for orange valve	
AU82PL	Bowl (Blue)	
AU92	Complete joy stick valve	
SF112V	Super flow valve	
SF2002-2	Spring for super flow & 92 (orange) valve	
SF2002-4	Washer for super flow valve	
SSWB145	Stainless steel water bowl bracket	
SSWB145K	Stainless steel water bowl bracket ** Kit **	
SSWBC15	Stainless steel water bowl clamp (for 1½" pipe)	
TSDRS	Rubber seat for hose kit	
WBC2	Water bowl clamp (2" sq.) (Powder-coated) Available in stainless steel	
WBC112	Water bowl clamp only	
SSFW38	¾" Stainless Steel Flat Washer	
SSHB382	¾" x 2" Stainless Steel hex bolt	
SSN38	¾" Stainless Steel Nut	
610-3055	¾" black plug	

## Water Bowls

Item	Description	
AU82C	Cast water bowl w/ super flow valve	
AU82P-SF	Poly water bowl w/ super flow valve	
SSWBAU82	Poly water bowl with super flow valve, stainless steel valve bracket & mounting bracket	
SSWBAU82L	Poly water bowl with super flow valve, stainless steel valve bracket & mounting bracket (large)	

## Miraco Waterers

Item	Description	
1HWF3330	3330 MiraFount 1 Hole Waterer	
2HWF3465	3465 MiraFount 2 Hole Waterer	
6400	Miraco Waterer	

**We Offer a Full Line of  
Miraco Waterers**

## Mats & Rubber Flooring

Item	Description	
GEM4872	Green Economy Mat for Walkway 47" x 72"	
MAYO139	Mayo Mat for Tie Stall and Free Stall 1" x 46" x 72" 5 Year Warranty on Tie Stall 10 Year Warranty on Free Stall	
MAYO13955-5571	Steel Strip for Mayo Mat (55" to 71" long)	
MSA14312	1/4 x 3 1/2 Mushroom Spike Mat anchor	
FW141	1/4" x 1" Mat washer	

## Feed Trough

Item	Description	
NFSS1244	Stainless Steel feed trough (per foot) 6 anchors @ 96"x28.5" section	
SSTC14134	Stainless Steel tapcons (for feed trough) use 7/32 hammer drill bit	
CK6x9	Tile 6" x 9"	
TP820	Trough PVC (per foot)	



**Mayo Mats  
with Steel  
Strips  
(Installed)**



**Stainless  
Steel Trough  
Installed**

**CK Manufacturing offers complete turnkey service for your tie stalls, including:**

- **Concrete Work**
- **Manufacturing**
- **Installation**

**CK Manufacturing, LLC**

THE DAIRY BARN SPECIALISTS

sales@ckmanufacturing.com  
OFFICE 717-464-2166  
330 Millwood Road  
Lancaster, PA 17603

[www.ckmanufacturing.com](http://www.ckmanufacturing.com)